

Milesight

AI Motorized Bullet Network Camera

NDA A 

IP67 + IK10

Motorized Lens



DATASHEET



KEY FEATURES

- ▶ NDA A Compliance (The fully NDA A-compliant products are well suited for government, defense and a range of projects subject to the NDA A.)
- ▶ Smart IR II (Combining the High Beam and Low Beam to adjust IR intensity to fit different lighting conditions.)
- ▶ 120dB Super WDR (Excellent performance even when the ratio of the luminosity of brightest and darkest is up to 120dB.)
- ▶ Advanced Functions (Boasting to support various advanced functions such as HLC, ROI.)
- ▶ 256G (Supporting ultra-large external microSD/SDHC/SDXC card storage up to 256G.)
- ▶ Adjustable 3-Axis Bracket (Providing a robust mounting platform for angle adjustments on a 3-axis plane.)
- ▶ Smart Stream (Bandwidth, storage and bit rate are saved with Smart Stream On, eg, H.265+ saves 70%~80% bandwidth that of H.264.)

AI Video Analytics

- 8 intelligent VCA modes powered by AI engine, which can intelligently filter objects to focus on human and vehicle detection.
- People Counting technology provides high accuracy and real-time data based on AI algorithm with statistic reports.



0.005Lux Ultra Low-light

The starlight camera is able to deliver high detailed color images even in low light environment reaching 0.005Lux(Color) or 0Lux(B/W), and near infrared light environments without any supplementary lighting.

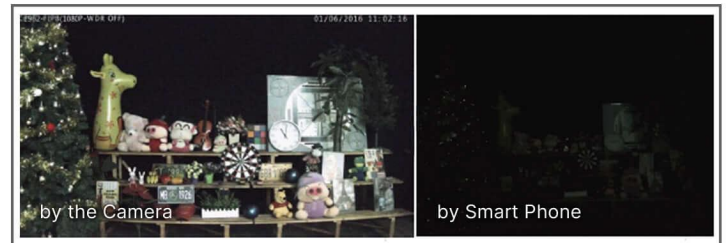

30fps@4K

Providing 4K HD resolution with frame rate of 30fps, the camera performs well in catching detailed image regardless of the moving speed.

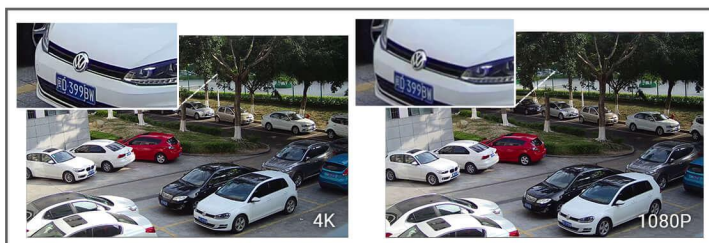

Integrated Junction Box

The well-designed integrated Junction Box especially the Clamshell structure ensures efficient and simple installation. It enlarges the space to make cable connection neat and as easy as a piece of cake.

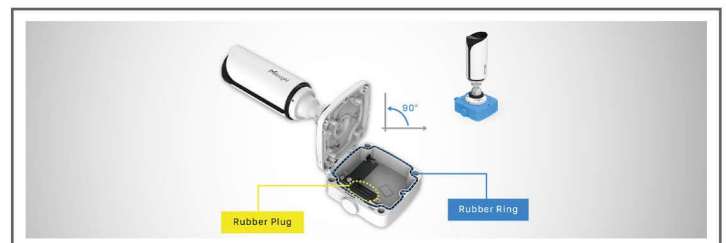

AI Motorized Bullet Network Camera



	Model	MS-C2964-RF(I)PA (2MP)	MS-C5364-F(I)PA (5MP)	MS-C8164-F(I)PA (4K)
Camera	Image Sensor	1/2.8" Progressive Scan CMOS		
	Min. Illumination	Color: 0.005Lux@F1.4 B/W: 0Lux with IR on	Color: 0.008Lux@F1.4 B/W: 0Lux with IR on	Color: 0.012Lux@F1.4 B/W: 0Lux with IR on
	WDR	120dB Super WDR		
	Shutter Time	1/100000s~1s		
	IR Distance	Up to 50m		
	Day/Night Mode	Day/Night/Auto/Customize/Schedule		
	S/N	>55dB		
Lens	Lens	Motorized 2.7~13.5mm/3.0~10.5mm/7~22mm@F1.4 P-Iris(Optional)		Motorized 2.7~13.5mm@F1.4 P-Iris(Optional)
	Field of View	H111°~H34°/D130°~D39°/V60°~V19° (2.7~13.5mm)	H99°~H31°/D124°~D38°/V72°~V23° (2.7~13.5mm)	H107°~H33°/D125°~D37° /V58°~V18°
		H100°~H33°/D115°~D38°/V54°~V18° (3.0~10.5mm)	H89°~H31°/D111°~D38°/V66°~V23° (3.0~10.5mm)	
		H42°~H17°/D48°~D19°/V24°~V9° (7~22mm)	H37°~H15°/D46°~D19°/V28°~V11° (7~22mm)	
	Mount	Φ14		
	Focus Control	Auto/Manual		
Iris Control (Optional for I Series)	Auto/Manual			
Video	Max. Image Resolution	1920x1080	2592x1944	3840x2160
	Primary Stream	60Hz: 60fps@(1920x1080, 1280x960, 1280x720, 704x576) 50Hz: 50fps@(1920x1080, 1280x960, 1280x720, 704x576)	60Hz: 30fps@(2592x1944, 2592x1520, 2048x1536, 1920x1080, 1280x960, 1280x720, 704x576) 50Hz: 25fps@(2592x1944, 2592x1520, 2048x1536, 1920x1080, 1280x960, 1280x720, 704x576)	60Hz: 30fps@(3840x2160, 3072x2048, 2592x1944, 2592x1520, 2048x1536, 1920x1080, 1280x960, 1280x720, 704x576) 50Hz: 25fps@(3840x2160, 3072x2048, 2592x1944, 2592x1520, 2048x1536, 1920x1080, 1280x960, 1280x720, 704x576)
	Secondary Stream	60Hz: 60fps@(704x576, 640x480, 640x360, 352x288, 320x240) 50Hz: 50fps@(704x576, 640x480, 640x360, 352x288, 320x240)	60Hz: 30fps@(704x576, 640x480, 640x360, 352x288, 320x240) 50Hz: 25fps@(704x576, 640x480, 640x360, 352x288, 320x240)	
	Tertiary Stream	60Hz: 30fps@(1280x720, 704x576, 640x480, 640x360, 352x288, 320x240) 50Hz: 25fps@(1280x720, 704x576, 640x480, 640x360, 352x288, 320x240)		
	Video Compression	H.265+/H.265(HEVC)/H.264+/H.264/MJPEG		
	Video Bit Rate	16Kbps~16Mbps(CBR/VBR Adjustable)		

AI Motorized Bullet Network Camera



Video	Privacy Masking	Up to 24 areas						
	ROI	Up to 8 areas						
	Image Setting	Brightness/Contrast/Saturation/Sharpness						
Interface	Ethernet	1*RJ45 10M/100M Ethernet Port						
	Audio I/O	1/1 (Multi-interface Version)						
	Alarm I/O	1/1 (Multi-interface Version)						
Network	Network Storage	NAS(Support NFS, SMB/CIFS), ANR						
	Protocol	IPv4/IPv6, ARP, TCP, UDP, RTCP, RTP, RTSP, RTMP, HTTP, HTTPS, DNS, DDNS, DHCP, FTP, NTP, SMTP, SNMP, UPnP, Bonjour, SIP, PPPoE, VLAN, 802.1x, QoS, IGMP, ICMP, SSL						
Audio	Audio Compression	G.711/AAC/G.722/G.726						
	Audio Sampling Rate	8/16/32/44.1/48KHz						
	Audio Bit Rate	16~256kbps						
	Two-way Audio	Support						
Intelligent Analytics	Video Analysis	Region Entrance, Region Exiting, Advanced Motion Detection, Tamper Detection, Line Crossing, Loitering, Object Left, Object Removed						
	People Counting&Report	Count the number of people entering or exiting, up to 4 detection areas for regional people counting						
System	Storage	Support microSD/SDHC/SDXC Card Local Storage, up to 256G						
	Advanced Function	Heat Map, BLC, HLC, 2D DNR, 3D DNR, AWB, IP Address Filtering, AGC, Anti-flicker, Corridor Mode, Deblur, Watermark						
	SIP/VoIP Support	Yes, Voice & Video-over-IP						
	Event Trigger	Motion Detection, Network Disconnection, etc.						
	Event Action	FTP Upload, SMTP Upload, SD Card Record, SIP Phone, HTTP Notification, etc.						
	System Compatibility	ONVIF Profile G & Q & S & T, API						
General	Working Temperature	-40°C~60°C						
	Working Humidity	0~90%(Non-condensing)						
	Power Supply	PoE (802.3af) / DC 12V±10%						
	Power Consumption	<table border="0"> <tr> <td>8W MAX</td> <td>8.5W MAX</td> <td>9W MAX</td> </tr> <tr> <td>10W MAX (With IR on)</td> <td>11W MAX (With IR on)</td> <td>11W MAX (With IR on)</td> </tr> </table>	8W MAX	8.5W MAX	9W MAX	10W MAX (With IR on)	11W MAX (With IR on)	11W MAX (With IR on)
	8W MAX	8.5W MAX	9W MAX					
	10W MAX (With IR on)	11W MAX (With IR on)	11W MAX (With IR on)					
	Housing	Vandal-proof IK10-rated Metal Housing / Up to IP67-rated for Weather-resistant Performance						
	Weight	825g						
Dimensions	Φ76mmX239.5mm							
Warranty	3/5 Years							



Structure Diagrams

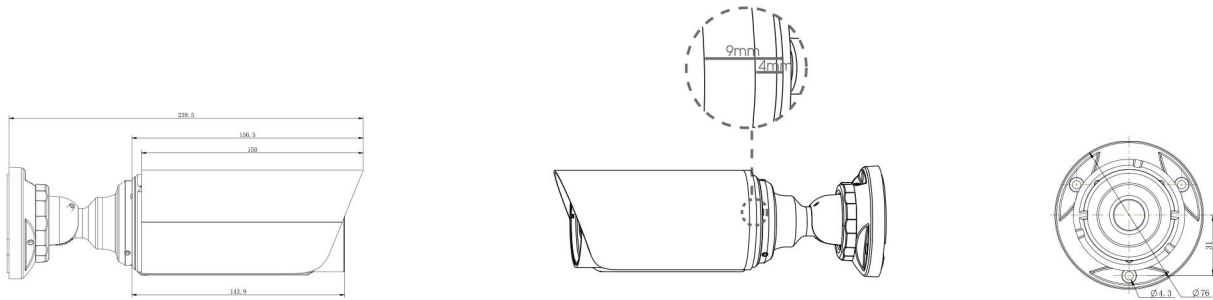
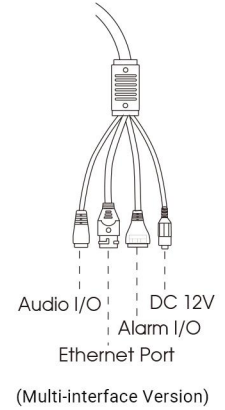
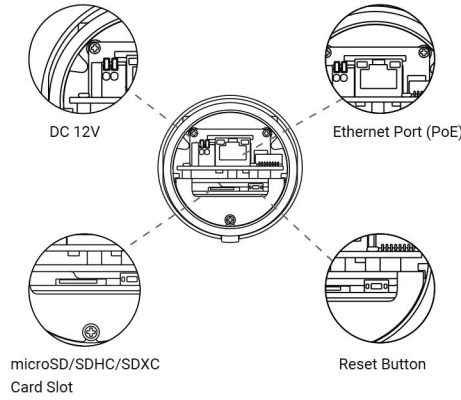
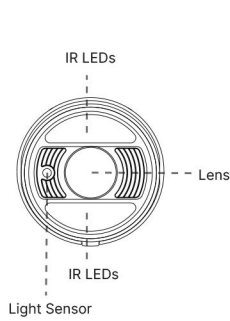

Units: mm

Accessories Support

A01 Pole Mount

Weight: 720g
Dimensions: 170*51.5*152.6mm



A03 External Corner Bracket

Weight: 900g
Dimensions: 170*152.5*76.3mm



A63 Junction Box

Weight: 620g
Dimensions: 134*126*40mm

